

PRORIL

60 Hz

GOVOX Series, these vortex pumps feature a less impeller wear and longer pump life by a vortex flow that allows fibrous materials and solid matters to be pumped out without obstruction.

Sewage Pump

GOVOX 475

Vortex Pump



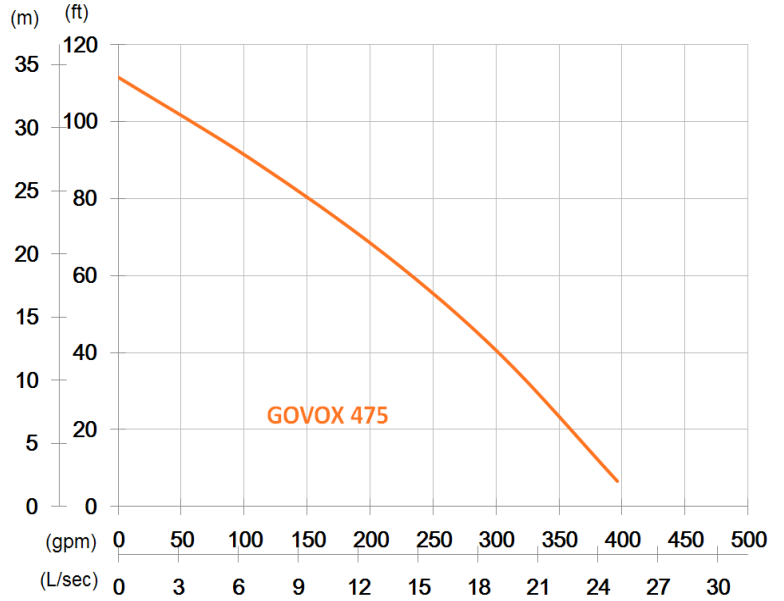

Shaft Speed : 3450 rpm

Outlet : 100mm, 4in

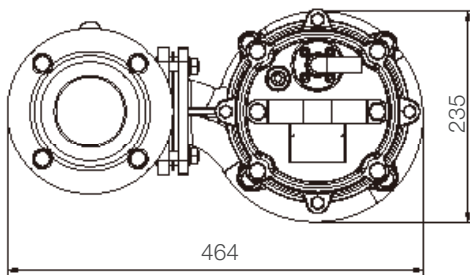

OUTPUT	HEAD	FLOW
7.5 kW	Rated : 20m, 66ft	Rated : 13 l/s, 211 gpm
10 HP	Max : 34m, 112ft	Max : 25 l/s, 396 gpm

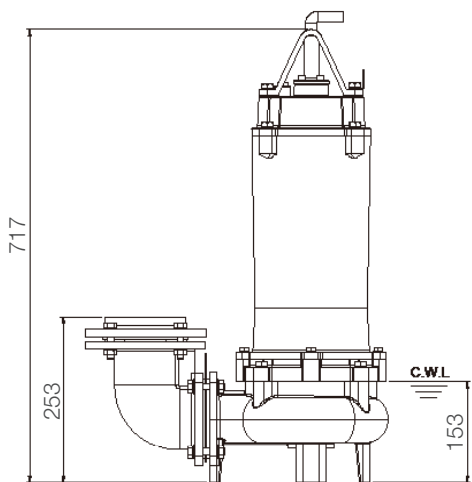

Weight : 75kg / 165 lbs

Pump Type	Electric Submersible Pumps	
	3-Phase	
Motor	Type	Induction Motor
	Poles	2 Pole
	Insulation	Class F
	Protector	Circle Thermal Protector
	Starter	D.O.L.
Lubricant	Food Grade (ISO VG32)	
Impeller Type	Vortex	
Shaft Seal	Double Mechanical Seal	
	Silicon Carbide VS Ceramic / Carbon	
Bearings	C3 Shielded ball bearings	
Cable	PVC (CSA Certified) / H07RN-F	
	33ft (10m) or longer upon request.	
Materials	Pump Casing	Gray Iron
	Impeller	Gray Iron
	Motor Frame	Gray Iron
	Motor Shaft	Stainless Steel
Max. Liquid Temperature	104°F (40°C)	
Max. Submersion Depth	66ft (20m)	
pH Range	pH 5 - pH 8	
Accessories	GRF-04	