

PRORIL

60 Hz

GOFLOW Series, these non-clog pumps can handle solids up to 37 mm in diameter without clogging. These pumps are equipped with a semi-open channel impeller, a wide channel for the pump to pass solids from inflow to discharge with minimal blockage.

Sewage Pump

GOFLOW 322

Non-clog Pump



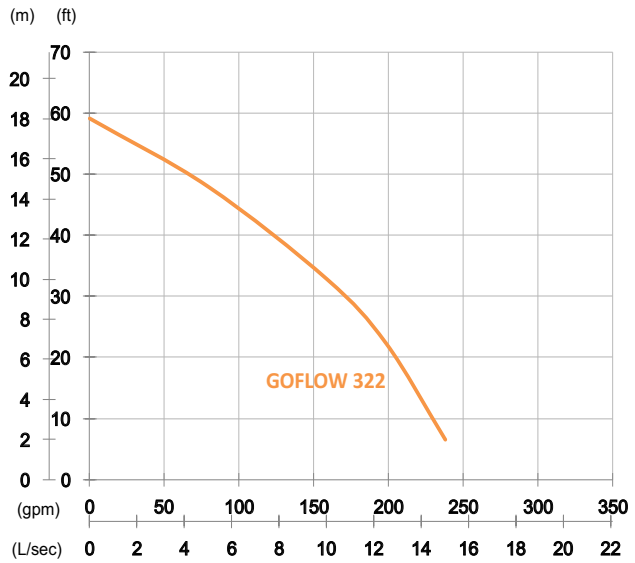

Shaft Speed : 3450 rpm

Outlet : 80mm, 3in

OUTPUT	HEAD	FLOW
2.2 kW	Rated : 10m, 33ft	Rated : 10 L/s, 159 gpm
3 HP	Max : 18m, 59ft	Max : 15 L/s, 238 gpm

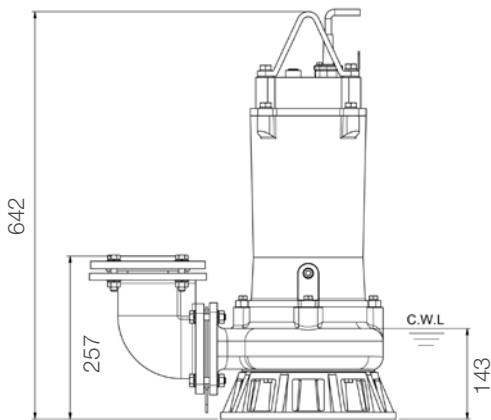
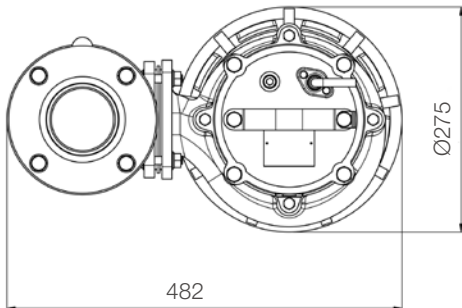

unit : mm

Weight : 55kg / 121 lbs

Pump Type	Electric Submersible Pumps	
	3-Phase	
Motor	Type	Induction Motor
	Poles	2 Pole
	Insulation	Class F
	Protector	Circle Thermal Protector
	Starter	D.O.L.
Lubricant	Food Grade (ISO VG32)	
Impeller Type	Semi-Open Channel	
Shaft Seal	Double Mechanical Seal	
	Silicon Carbide VS Ceramic / Carbon	
Bearings	C3 Shielded ball bearings	
Cable	PVC (CSA Certified) / H07RN-F	
	10m (33ft) or longer upon request.	
Materials	Pump Casing	Gray Iron
	Impeller	Gray Iron
	Motor Frame	Gray Iron
	Motor Shaft	Stainless Steel
Max. Liquid Temperature	40°C (104°F)	
Max. Submersion Depth	20m (66ft)	
pH Range	pH 5 - pH 8	
Accessories	GRF-03	