

PRORIL

60 Hz

GOVOX-G Series, these vortex pumps feature a less impeller wear and longer pump life by a vortex flow that allows fibrous materials and solid matters to be pumped out without obstruction.

Sewage Pump

GOVOX-G 322

Vortex Pump



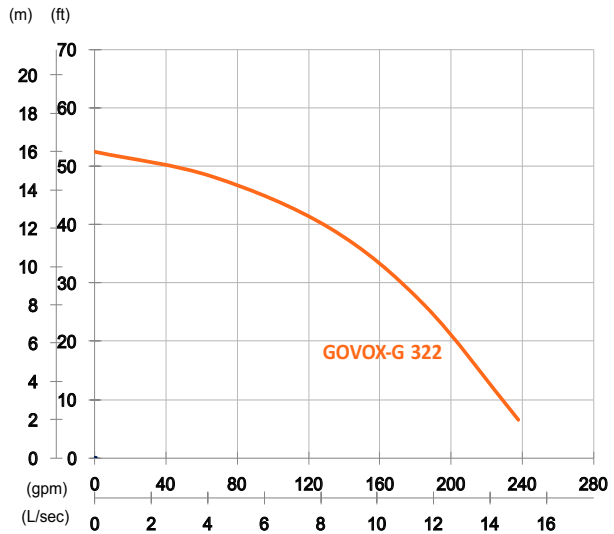

Shaft Speed : 3450 rpm

Outlet : 80mm, 3in

OUTPUT	HEAD	FLOW
2.2 kW	Rated : 12m, 39ft	Rated : 8.3 L/s, 132 gpm
3 HP	Max : 16m, 52ft	Max : 15 L/s, 238 gpm

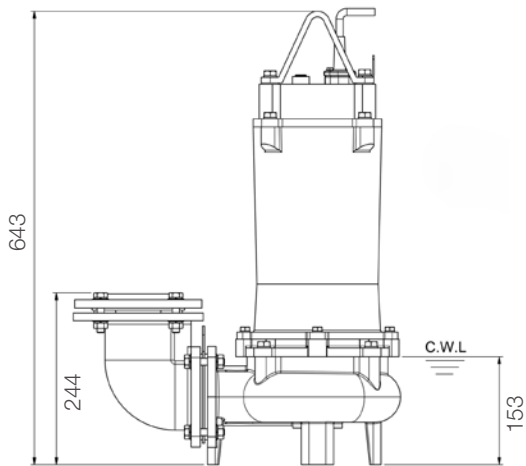
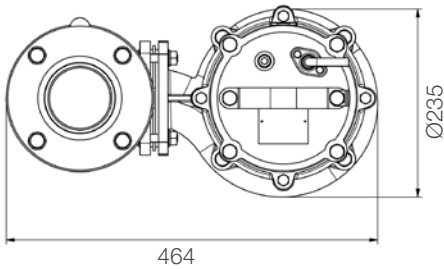

unit : mm

Weight : 60kg / 132 lbs

Pump Type	Electric Submersible Pumps	
	3-Phase	
Motor	Type	Induction Motor
	Poles	2 Pole
	Insulation	Class F
	Protector	Circle Thermal Protector
	Starter	D.O.L.
Lubricant	Food Grade (ISO VG32)	
Impeller Type	Vortex	
Shaft Seal	Double Mechanical Seal	
	Silicon Carbide VS Ceramic / Carbon	
Bearings	C3 Shielded ball bearings	
Cable	PVC (CSA Certified) / H07RN-F	
	10m (33ft) or longer upon request.	
Materials	Pump Casing	Gray Iron
	Impeller	Gray Iron
	Motor Frame	Gray Iron
	Motor Shaft	Stainless Steel
Max. Liquid Temperature	40°C (104°F)	
Max. Submersion Depth	20m (66ft)	
pH Range	pH 5 - pH 8	
Accessories	GRF-03	