

PRORIL

60 Hz

GOBITS Series, these grinder pumps meet the demanding needs of commercial and residential sewage applications. GOBITS series pumps employ a grinding mechanism to effectively grind and transfer solids under high pressure from one place to a higher or a distant place. Ideal for residential and low-pressure sewer applications.

Sewage Pump

GOBITS 15

Grinder Pump





Shaft Speed : 3450 rpm

Outlet : 32mm, 1.25in

OUTPUT	HEAD	FLOW
1.5 kW	Rated : 15m, 49ft	Rated : 1 L/s, 16 gpm
2 HP	Max : 23m, 75ft	Max : 2.8 L/s, 45 gpm

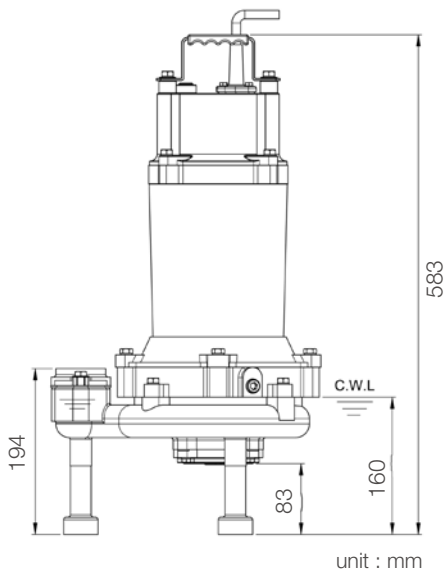
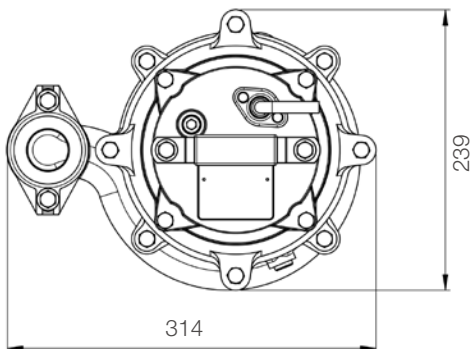

Weight : 35kg / 77 lbs

Pump Type	Electric Submersible Pumps	
	1-Phase, 3-Phase	
Motor	Type	Induction Motor
	Poles	2 Pole
	Insulation	Class F
	Protector	Circle Thermal Protector
	Starter	1-Phase · Capacitor-Run, 3-Phase · D.O.L.
Lubricant	Food Grade (ISO VG32)	
Impeller Type	Vortex	
Shaft Seal	Double Mechanical Seal	
	Silicon Carbide VS Ceramic / Carbon	
Bearings	C3 Shielded ball bearings	
Cable	PVC (CSA Certified) / H07RN-F	
	10m (33ft) or longer upon request.	
Materials	Pump Casing	Gray Iron
	Impeller	Gray Iron
	Motor Frame	Gray Iron
	Motor Shaft	Stainless Steel
	Grinder Set	Chromium Iron
Max. Liquid Temperature	40°C (104°F)	
Max. Submersion Depth	20m (66ft)	
pH Range	pH 5 - pH 8	
Accessories	GRL-02	