

PRORIL

50 Hz

Designed for continuous operations, excellent performance and easy maintenance, PRORIL Tank series pumps have proven their reliability and durability in demanding areas like construction, mining, tunneling, quarries, industries and rental applications.

Dewatering Pump

TANK 237

High Chrome Dewatering Pump



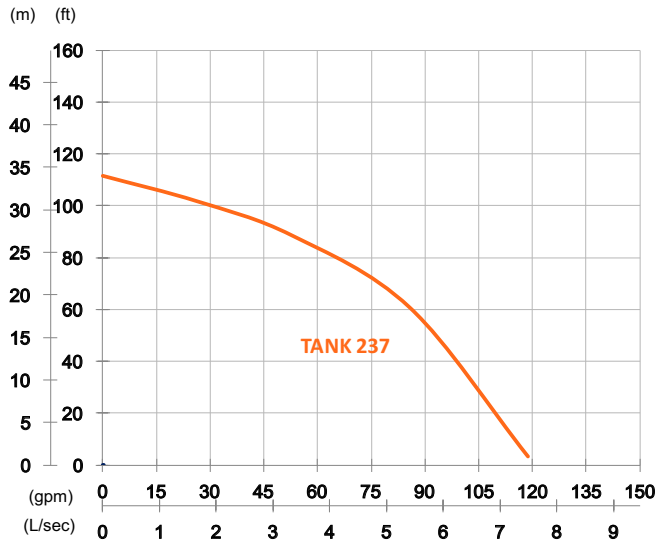

Shaft Speed : 2850 rpm

Outlet : 50mm, 2in

OUTPUT	HEAD	FLOW
3.7 kW	Rated : 27m, 89ft	Rated : 3.3 L/s, 53 gpm
5 HP	Max : 34m, 112ft	Max : 7.5 L/s, 119 gpm

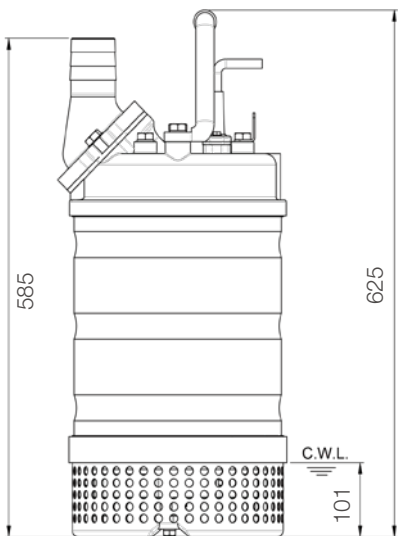
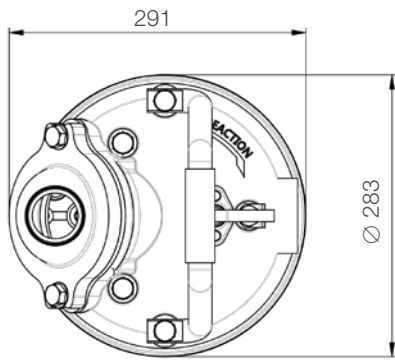

unit : mm

Weight : 61kg / 134 lbs

Pump Type		Electric Submersible Pumps
		3-Phase
Motor	Type	Induction Motor
	Poles	2 Pole
	Insulation	Class F
	Protector	Circle Thermal Protector
	Starter Method	D.O.L.
Lubricant		Food Grade (ISO VG32)
Impeller Type		Opened
Shaft Seal		Double Mechanical Seal
		Silicon Carbide VS Ceramic / Carbon
Bearings		C3 Shielded ball bearings
Cable		PVC (CSA Certified) / H07RN-F
		10m (33ft) or longer upon request.
Materials	Pump Casing	Gray Iron
	Impeller	Chromium Iron
	Motor Frame	Stainless Steel
	Motor Shaft	Stainless Steel
	Strainer	Stainless Steel
Max. Liquid Temperature		40°C (104°F)
Max. Submersion Depth		20m (66ft)
pH Range		pH 5 - pH 8