

PRORIL

60 Hz

Designed for continuous operations, excellent performance and easy maintenance, PRORIL Tank series pumps have proven their reliability and durability in demanding areas like construction, mining, tunneling, quarries, industries and rental applications.

Dewatering Pump

TANK 4150

High Chrome Dewatering Pump



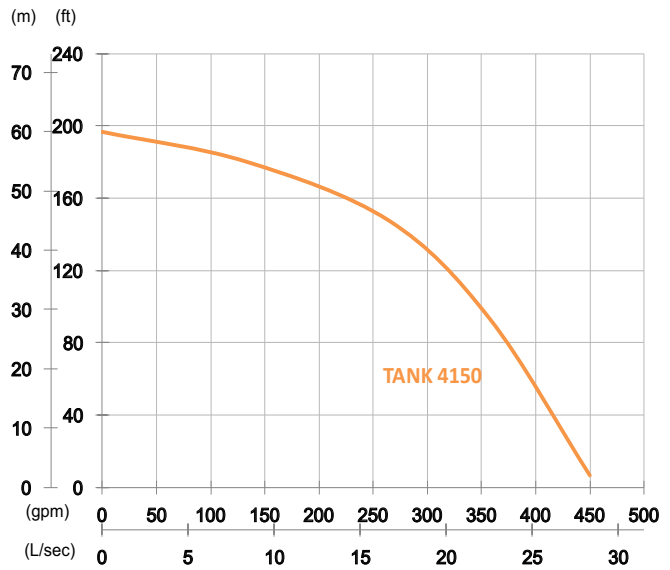

Shaft Speed : 3450 rpm

Outlet : 100mm, 4in

OUTPUT	HEAD	FLOW
15 kW	Rated : 45m, 148ft	Rated : 16.7 L/s, 264 gpm
20 HP	Max : 60m, 197ft	Max : 28.3 L/s, 449 gpm

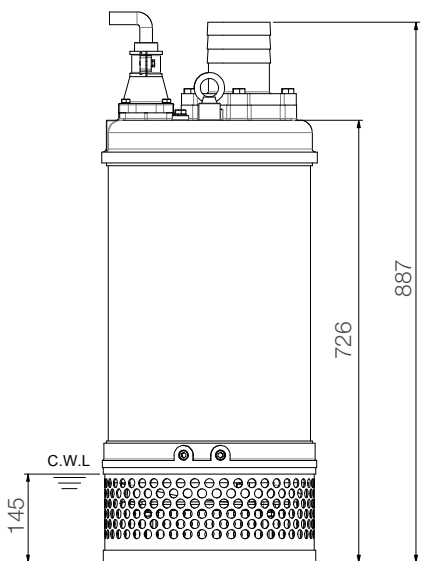
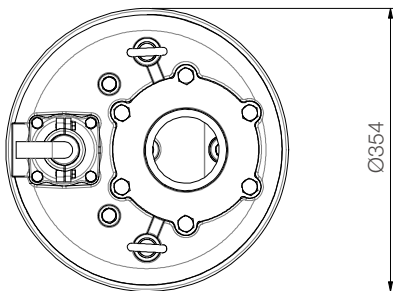

unit : mm

Weight : 141kg / 311 lbs

Pump Type	Electric Submersible Pumps	
	3-Phase	
Motor	Type	Induction Motor
	Poles	2 Pole
	Insulation	Class F
	Protector	Circle Thermal Protector
	Starter	D.O.L.
Lubricant	Food Grade (ISO VG32)	
Impeller Type	Opened	
Shaft Seal	Double Mechanical Seal	
	Silicon Carbide VS Ceramic / Carbon	
Bearings	C3 Shielded ball bearings	
Cable	PVC (CSA Certified) / H07RN-F	
	10m (33ft) or longer upon request.	
Materials	Pump Casing	Gray Iron
	Impeller	Chromium Iron
	Motor Frame	Gray Iron
	Motor Shaft	Stainless Steel
	Strainer	Stainless Steel
Max. Liquid Temperature	40°C (104°F)	
Max. Submersion Depth	20m (66ft)	
pH Range	pH 5 - pH 8	