

PRORIL

60 Hz

Rugged, reliable and cost effective, the Titan series pumps deliver excellent performance and serve a wide range of tough dewatering applications like mines, construction site, rental applications and other demanding industries.

Dewatering Pump

TITAN 6110

Heavy Duty Dewatering Pump



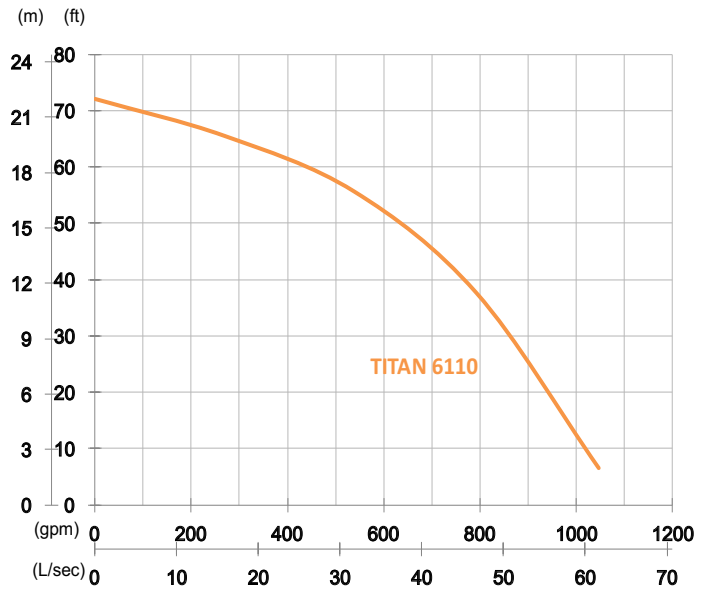

Shaft Speed : 1750 rpm

Outlet : 150mm, 6in

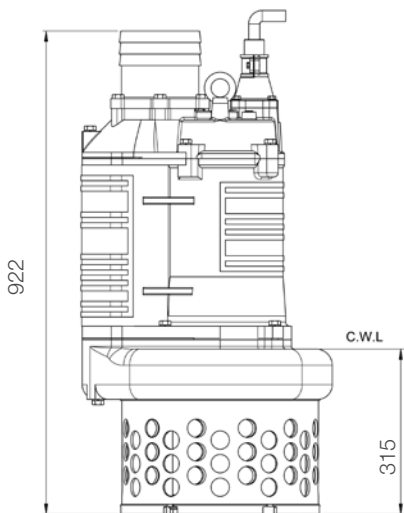
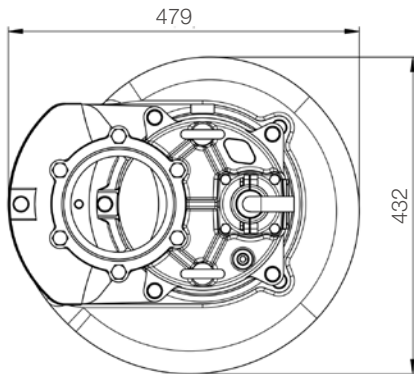

unit : mm

Weight : 196kg / 432 lbs

OUTPUT	HEAD	FLOW
11 kW	Rated : 17m, 56ft	Rated : 31.7 L/s, 502 gpm
15 HP	Max : 22m, 72ft	Max : 61.7 L/s, 977 gpm

Pump Type	Electric Submersible Pumps	
	3-Phase	
Motor	Type	Induction Motor
	Poles	4 Pole
	Insulation	Class F
	Protector	Circle Thermal Protector
	Starter	D.O.L.
Lubricant	Food Grade (ISO VG32)	
Impeller Type	Opened	
Shaft Seal	Double Mechanical Seal	
	Silicon Carbide VS Ceramic / Carbon	
Bearings	C3 Shielded ball bearings	
Cable	PVC (CSA Certified) / H07RN-F	
	10m (33ft) or longer upon request.	
Materials	Pump Casing	Ductile Iron
	Impeller	Chromium Iron
	Motor Frame	Gray Iron
	Motor Shaft	Stainless Steel
	Strainer	Carbon Steel
Max. Liquid Temperature	40°C (104°F)	
Max. Submersion Depth	20m (66ft)	
pH Range	pH 5 - pH 8	