

# PRORIL

50 Hz

X-VOX Series, all components in contact with liquid of the stainless steel vortex pumps are made of 304 stainless steel. These pumps are designed for handling clean water or screened wastewater. With the use of the food-graded lubricant, they are also applicable to the aquaculture industry.

**Stainless Steel Pump**

## **X-VOX 215**

Sewage Vortex Pump



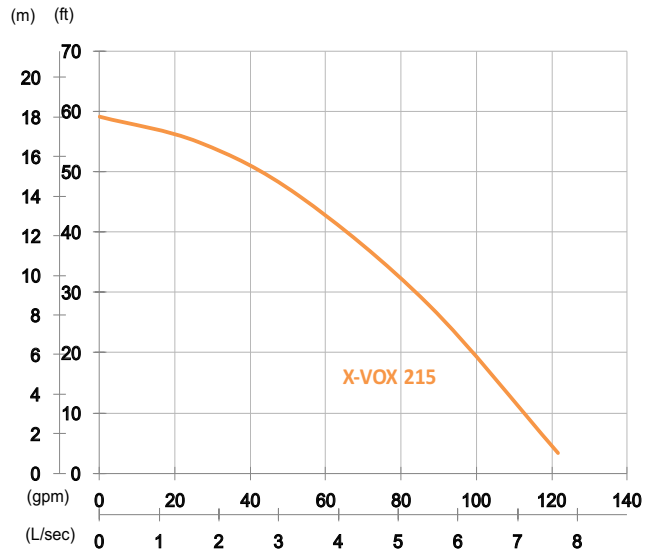

Shaft Speed : 2850 rpm

Outlet : 50mm, 2in

OUTPUT	HEAD	FLOW
1.5 kW	Rated : 14m, 46ft	Rated : 3.3 L/s, 53 gpm
2 HP	Max : 18m, 59ft	Max : 7.7 L/s, 121 gpm

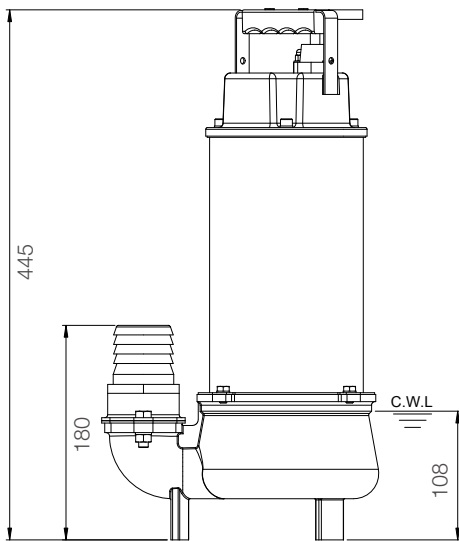
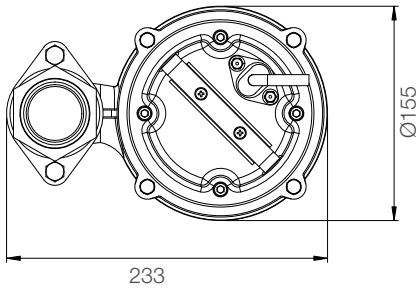

unit : mm

Weight : 15kg / 33 lbs

Pump Type	Electric Submersible Pumps	
	1-Phase, 3-Phase	
Motor	Type	Induction Motor
	Poles	2 Pole
	Insulation	Class F
	Protector	Circle Thermal Protector
	Starter	1-Phase · Capacitor-Run, 3-Phase · D.O.L.
Lubricant	Food Grade (ISO VG32)	
Impeller Type	Vortex	
Shaft Seal	Double Mechanical Seal	
	Silicon Carbide VS Ceramic / Carbon	
Bearings	C3 Shielded ball bearings	
Cable	PVC (CSA Certified) / H07RN-F	
	6m (20ft) or longer upon request.	
Materials	Pump Casing	Stainless Steel
	Impeller	Stainless Steel
	Motor Frame	Stainless Steel
	Motor Shaft	Stainless Steel
Max. Liquid Temperature	40°C (104°F)	
Max. Submersion Depth	20m (66ft)	
pH Range	pH 5 - pH 8	