

PRORIL

50 Hz

Rugged, reliable and cost effective, the Titan series pumps deliver excellent performance and serve a wide range of tough dewatering applications like mines, construction site, rental applications and other demanding industries.

Dewatering Pump

TITAN 355

Heavy Duty Dewatering Pump



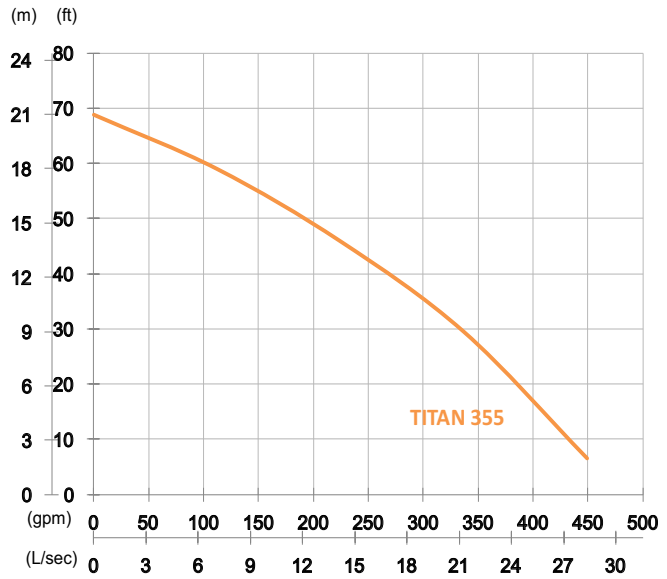

Shaft Speed : 1450 rpm

Outlet : 80mm, 3in

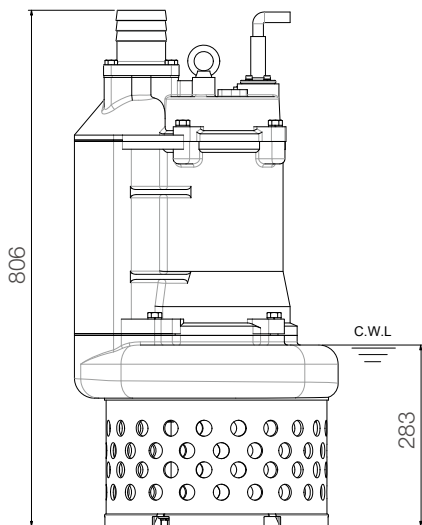
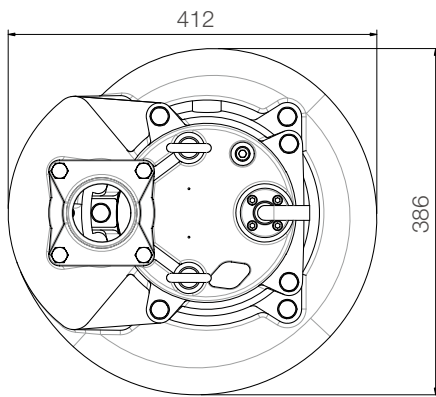

unit : mm

Weight : 128kg / 282 lbs

OUTPUT	HEAD	FLOW
5.5 kW	Rated : 14m, 46ft	Rated : 14.2 L/s, 224 gpm
7.5 HP	Max : 21m, 69ft	Max : 28.3 L/s, 449 gpm

Pump Type	Electric Submersible Pumps	
	3-Phase	
Motor	Type	Induction Motor
	Poles	4 Pole
	Insulation	Class F
	Protector	Circle Thermal Protector
	Starter	D.O.L.
Lubricant	Food Grade (ISO VG32)	
Impeller Type	Opened	
Shaft Seal	Double Mechanical Seal	
	Silicon Carbide VS Ceramic / Carbon	
Bearings	C3 Shielded ball bearings	
Cable	PVC (CSA Certified) / H07RN-F	
	10m (33ft) or longer upon request.	
Materials	Pump Casing	Ductile Iron
	Impeller	Chromium Iron
	Motor Frame	Gray Iron
	Motor Shaft	Stainless Steel
	Strainer	Carbon Steel
Max. Liquid Temperature	40°C (104°F)	
Max. Submersion Depth	20m (66ft)	
pH Range	pH 5 - pH 8	