

PRORIL

50 Hz

GOSPIN Series, the classical drainage pumps with strainer and rigid casting are engineered for various effluent pumping applications in commercial and industrial sectors.

Sewage Pump

GOSPIN 437

Drainage Pump



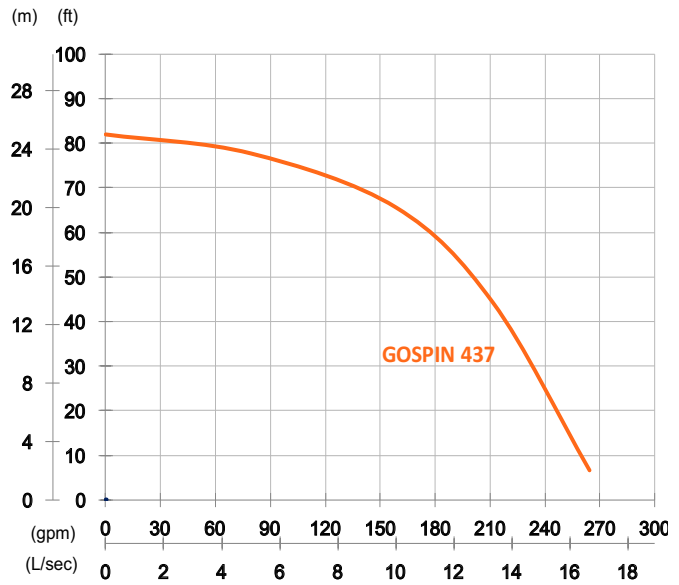

Shaft Speed : 2850 rpm

Outlet : 100mm, 4in

OUTPUT	HEAD	FLOW
3.7 kW	Rated : 20m, 66ft	Rated : 10 L/s, 158 gpm
5 HP	Max : 25m, 82ft	Max : 16.7 L/s, 264 gpm

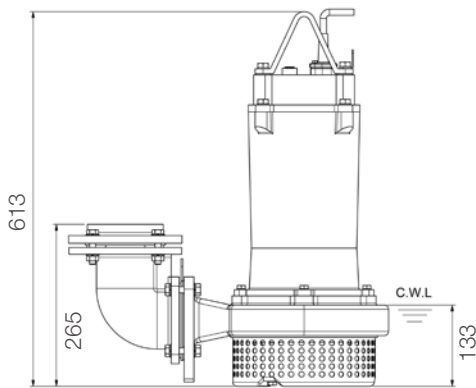
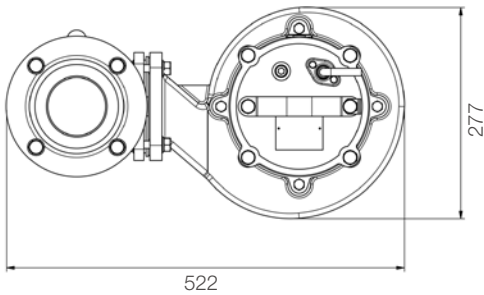

unit : mm

Weight : 56kg / 123 lbs

Pump Type		Electric Submersible Pumps
		3-Phase
Motor	Type	Induction Motor
	Poles	2 Pole
	Insulation	Class F
	Protector	Circle Thermal Protector
	Starter	D.O.L.
Lubricant		Food Grade (ISO VG32)
Impeller Type		Semi-Open
Shaft Seal		Double Mechanical Seal
		Silicon Carbide VS Ceramic / Carbon
Bearings		C3 Shielded ball bearings
Cable		PVC (CSA Certified) / H07RN-F
		10m (33ft) or longer upon request.
Materials	Pump Casing	Gray Iron
	Impeller	Gray Iron
	Motor Frame	Gray Iron
	Motor Shaft	Stainless Steel
	Strainer	Stainless Steel
Max. Liquid Temperature		40°C (104°F)
Max. Submersion Depth		20m (66ft)
pH Range		pH 5 - pH 8
Accessories		GRF-04