

PRORIL

50 Hz

GOVOX Series, these vortex pumps feature a less impeller wear and longer pump life by a vortex flow that allows fibrous materials and solid matters to be pumped out without obstruction.

Sewage Pump

GOVOX 208

Vortex Pump



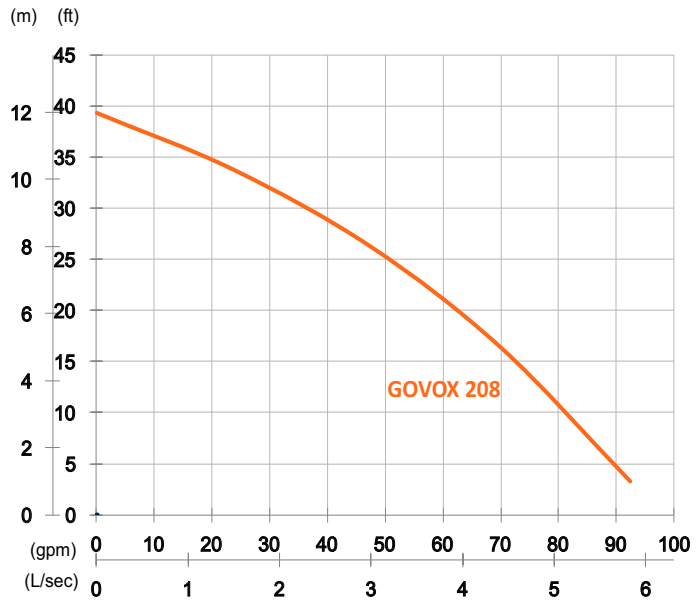

Shaft Speed : 2850 rpm

Outlet : 50mm, 2in

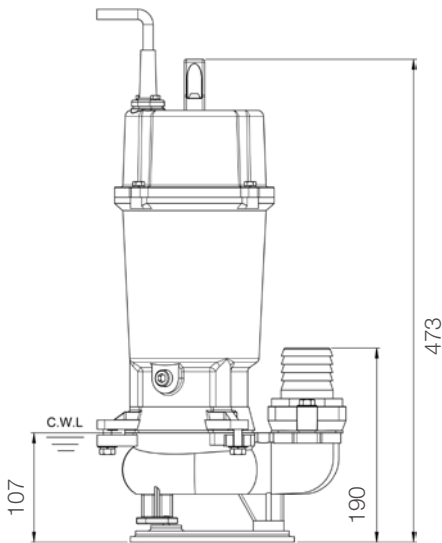
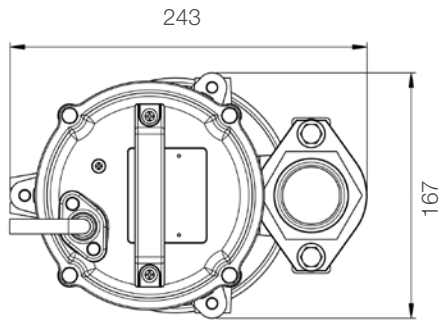

unit : mm

Weight : 20kg / 44 lbs

OUTPUT	HEAD	FLOW
0.75 kW	Rated : 8m, 26ft	Rated : 3 L/s, 48 gpm
1 HP	Max : 12m, 39ft	Max : 5.8 L/s, 92 gpm

Pump Type	Electric Submersible Pumps	
	1-Phase, 3-Phase	
Motor	Type	Induction Motor
	Poles	2 Pole
	Insulation	Class F
	Protector	Circle Thermal Protector
	Starter	1-Phase · Capacitor-Run, 3-Phase · D.O.L.
Lubricant	Food Grade (ISO VG32)	
Impeller Type	Vortex	
Shaft Seal	Double Mechanical Seal	
	Silicon Carbide VS Ceramic / Carbon	
Bearings	C3 Shielded ball bearings	
Cable	PVC (CSA Certified) / H07RN-F	
	6m (20ft) or longer upon request.	
Materials	Pump Casing	Gray Iron
	Impeller	Gray Iron
	Motor Frame	Gray Iron
	Motor Shaft	Stainless Steel
Max. Liquid Temperature	40°C (104°F)	
Max. Submersion Depth	20m (66ft)	
pH Range	pH 5 - pH 8	
Accessories	GRL-02	