

PRORIL

50 Hz

GOVOX-U Series, these vortex pumps feature a less impeller wear and longer pump life by a vortex flow that allows fibrous materials and solid matters to be pumped out without obstruction.

Sewage Pump

GOVOX-U 322

Vortex Pump



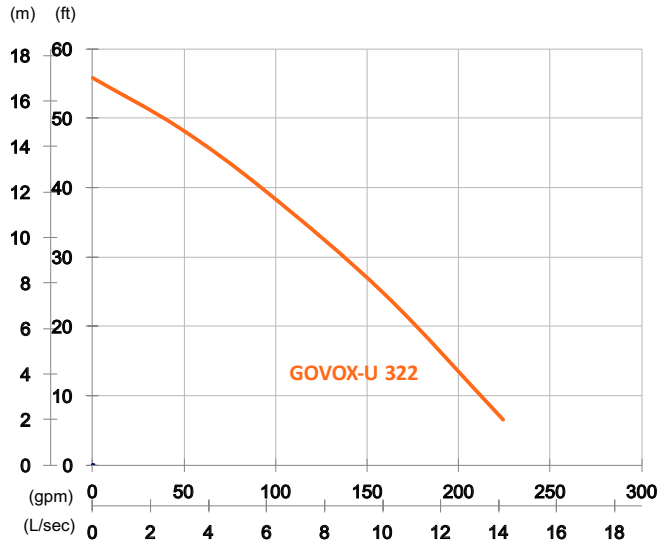

Shaft Speed : 2850 rpm

Outlet : 80mm, 3in

OUTPUT	HEAD	FLOW
2.2 kW	Rated : 12m, 39ft	Rated : 6 L/s, 95 gpm
3 HP	Max : 17m, 56ft	Max : 14.2 L/s, 224 gpm

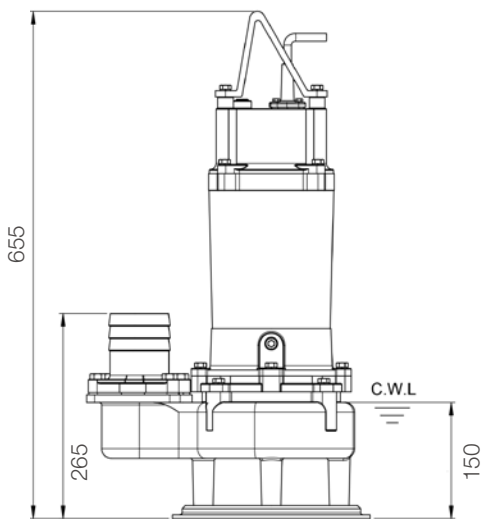
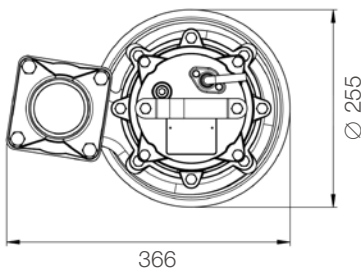

unit : mm

Weight : 40kg / 88 lbs

Pump Type		Electric Submersible Pumps
		3-Phase
Motor	Type	Induction Motor
	Poles	2 Pole
	Insulation	Class F
	Protector	Circle Thermal Protector
	Starter Method	D.O.L.
Lubricant		Food Grade (ISO VG32)
Impeller Type		Vortex
Shaft Seal		Double Mechanical Seal Silicon Carbide VS Ceramic / Carbon
Bearings		C3 Shielded ball bearings
Cable		PVC (CSA Certified) / H07RN-F 10m (33ft) or longer upon request.
Materials	Pump Casing	Ductile Iron
	Impeller	Gray Iron
	Motor Frame	Gray Iron
	Motor Shaft	Stainless Steel
Max. Liquid Temperature		40°C (104°F)
Max. Submersion Depth		20m (66ft)
pH Range		pH 5 - pH 8