

# PRORIL

50 Hz

GOVOX-U Series, these vortex pumps feature a less impeller wear and longer pump life by a vortex flow that allows fibrous materials and solid matters to be pumped out without obstruction.

Sewage Pump

## GOVOX-U 455

Vortex Pump



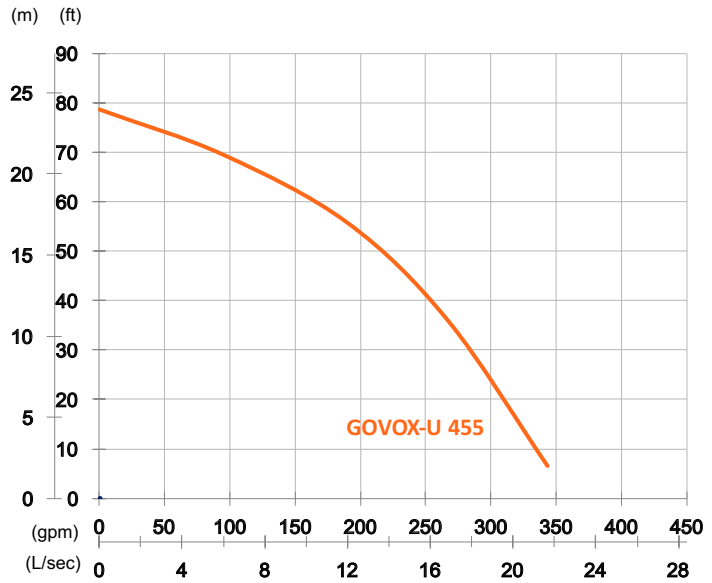

Shaft Speed : 2850 rpm

Outlet : 100mm, 4in

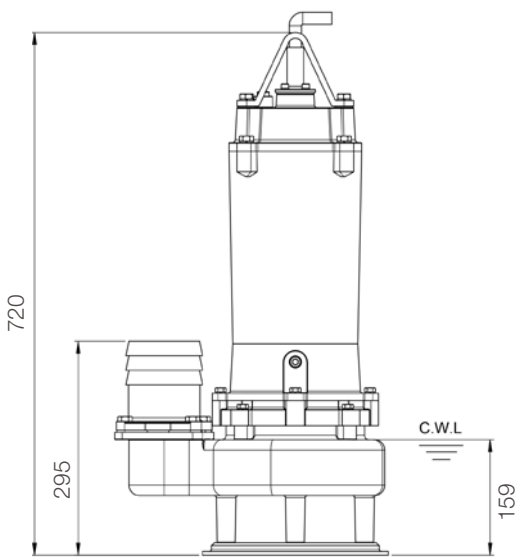
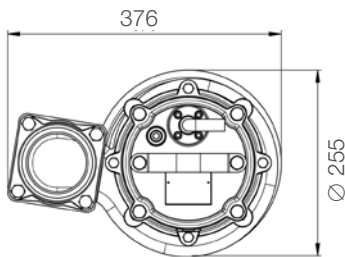

unit : mm

Weight : 60kg / 132 lbs

OUTPUT	HEAD	FLOW
5.5 kW	Rated : 17m, 56ft	Rated : 12 L/s, 190 gpm
7.5 HP	Max : 24m, 79ft	Max : 21.7 L/s, 343 gpm

Pump Type	Electric Submersible Pumps	
	3-Phase	
Motor	Type	Induction Motor
	Poles	2 Pole
	Insulation	Class F
	Protector	Circle Thermal Protector
	Starter Method	D.O.L.
Lubricant	Food Grade (ISO VG32)	
Impeller Type	Vortex	
Shaft Seal	Double Mechanical Seal	
	Silicon Carbide VS Ceramic / Carbon	
Bearings	C3 Shielded ball bearings	
Cable	PVC (CSA Certified) / H07RN-F	
	10m (33ft) or longer upon request.	
Materials	Pump Casing	Ductile Iron
	Impeller	Gray Iron
	Motor Frame	Gray Iron
	Motor Shaft	Stainless Steel
Max. Liquid Temperature	40°C (104°F)	
Max. Submersion Depth	20m (66ft)	
pH Range	pH 5 - pH 8	